



## READ THIS FIRST

Be sure to use a pair of sharp hobby clippers to remove the miniature components from the frame. Carefully clean the excess material and mold lines with a sharp hobby knife. Check the fit of each part before gluing. Use a small amount of hobby plastic glue to assemble the components. Use caution with all products and follow all manufacturer instructions. Adult supervision is recommended for children under the age of 16. Have fun!

## JOIN THE COMMUNITY

Use #MyStarWarsLegion to share your miniature photos and be a part of the *Star Wars™: Legion* community!



AtomicMassGames



AtomicMassGames



Atomic\_Mass\_Transmissions

### LM-432 CRAB DROID

SWQ134 ASSEMBLY (1)

STEP 1

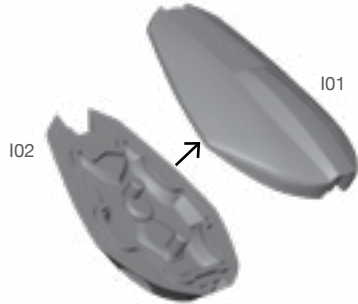

STEP 2



STEP 3

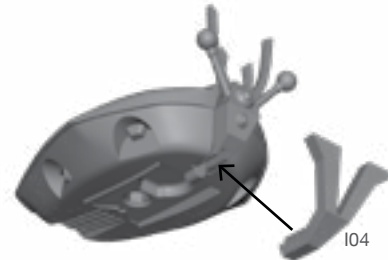

STEP 4

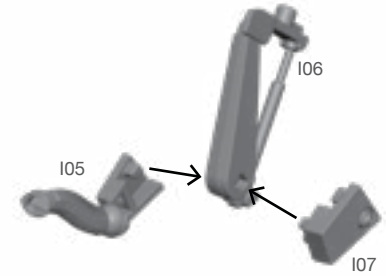

STEP 5

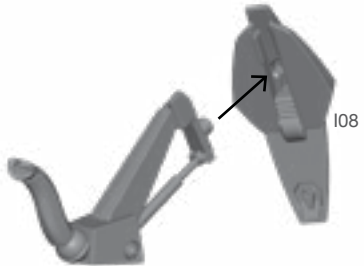

STEP 6

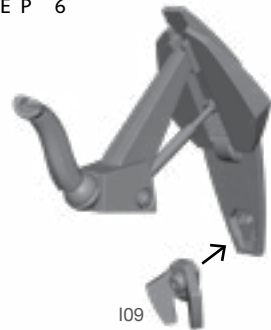

STEP 7



STEP 8

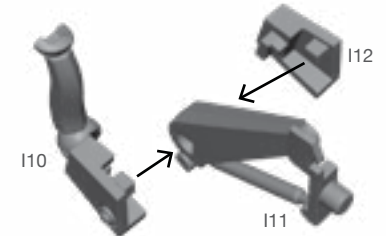

STEP 9

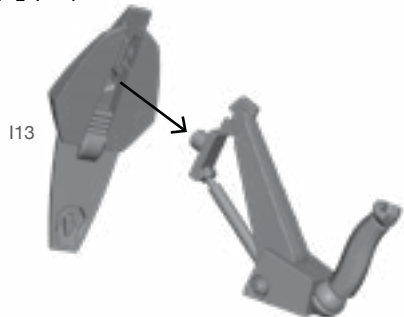

STEP 10



STEP 11



STEP 12

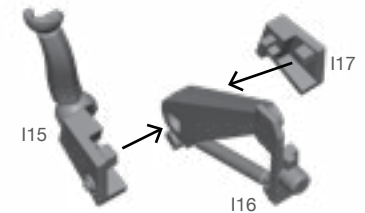

# LM-432 CRAB DROID

## SWQ134 ASSEMBLY (1)

