

# STAR WARS

## SHATTERPOINT™

### SWP06 (A)-OBI-WAN KENOBI

#### READ THIS FIRST

Be sure to use a pair of sharp hobby clippers to remove the miniature components from the frame. Carefully clean the excess material and mold lines via sharp hobby knife. Check the fit of each part before gluing. Use a small amount of hobby plastic glue to assemble the components. Use caution with all products and follow all manufacturer instructions. Adult supervision is recommended for children under the age of 16. Have fun!

#### JOIN THE COMMUNITY

Use #ShatterPaint to share your miniature photos and be a part of the Star Wars™: Shatterpoint community!

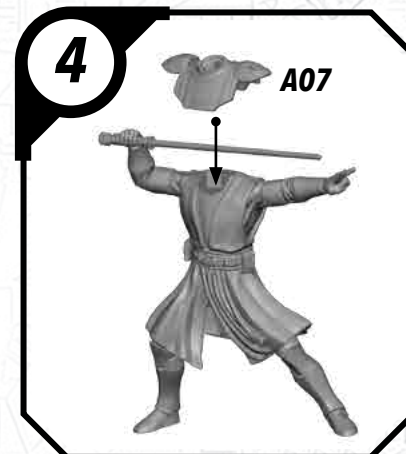
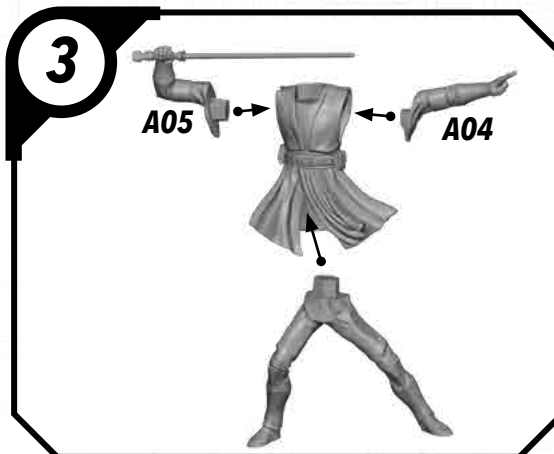
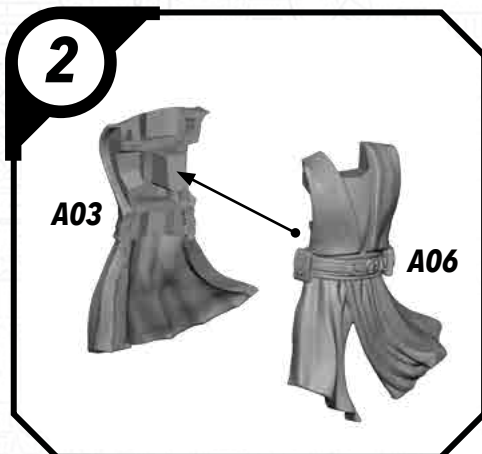
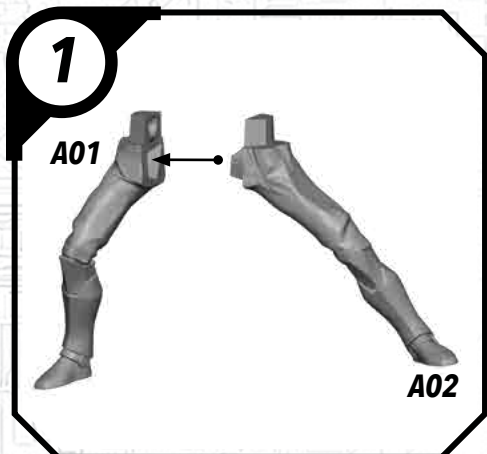
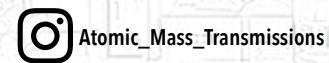

ALL PARTS SHOULD BE ASSEMBLED USING PLASTIC GLUE. PERMISSION GRANTED TO PRINT OR PHOTOCOPY FOR PERSONAL USE.

# SWP06 (B)-CODY

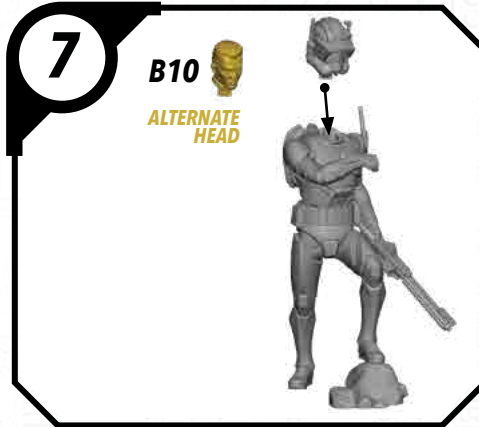
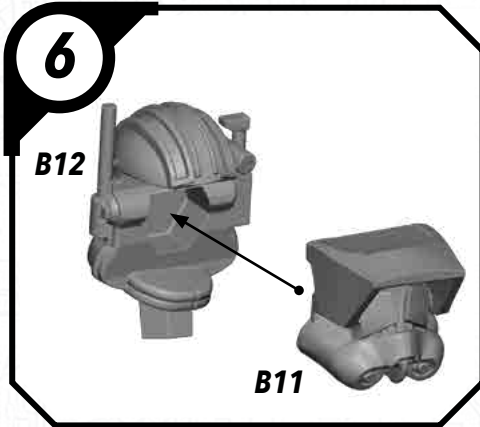
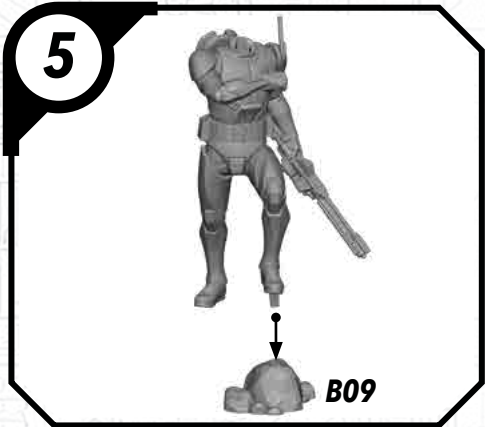
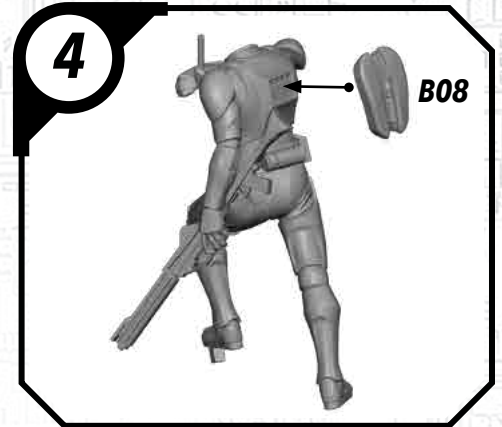
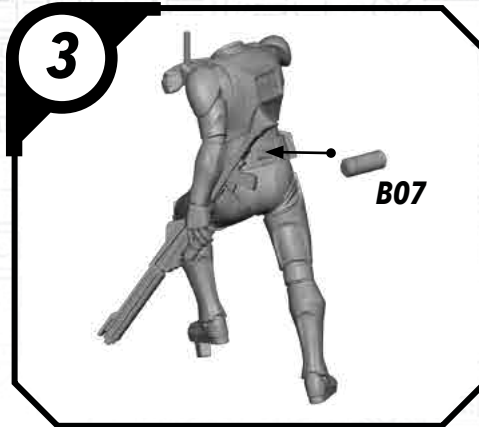
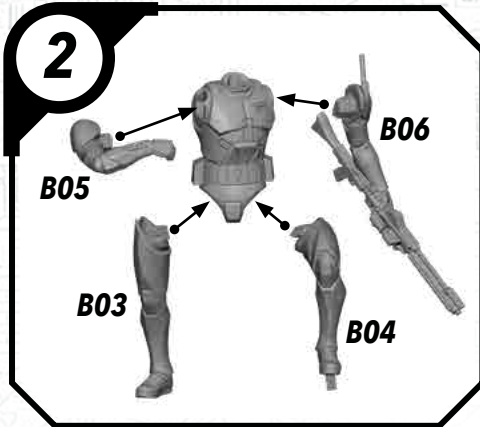
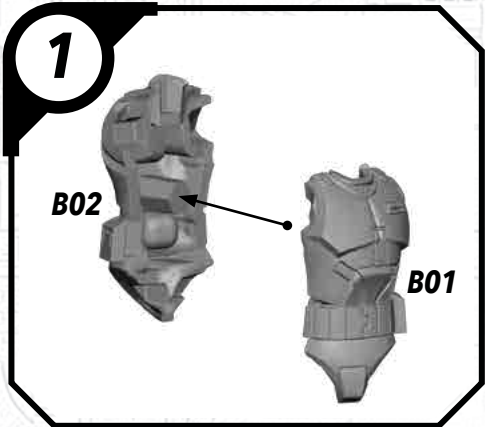

ALL PARTS SHOULD BE ASSEMBLED USING PLASTIC GLUE. PERMISSION GRANTED TO PRINT OR PHOTOCOPY FOR PERSONAL USE.

# SWP06 (C)-CLONE TROOPER POSE B

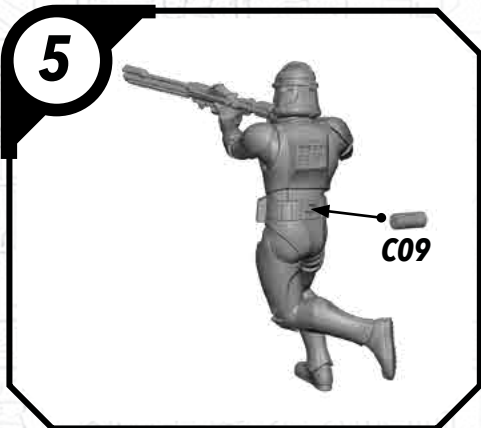
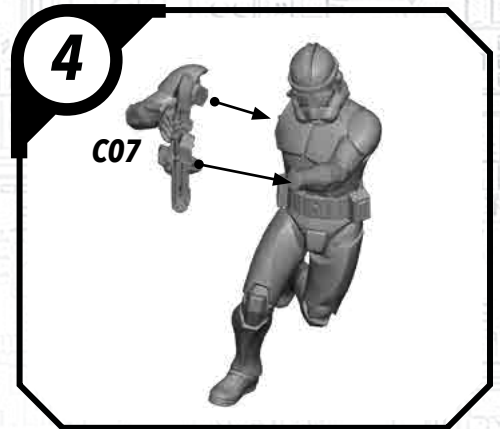
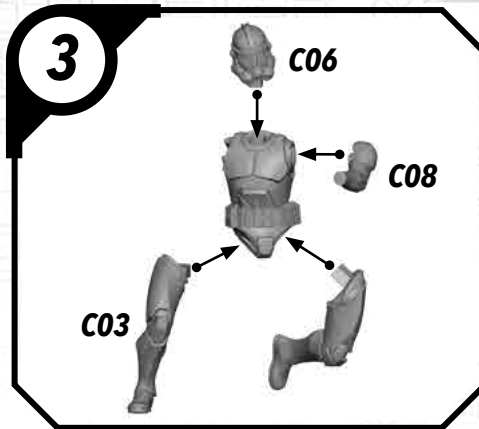
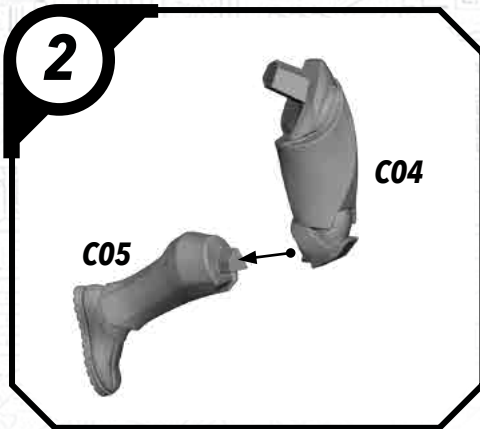
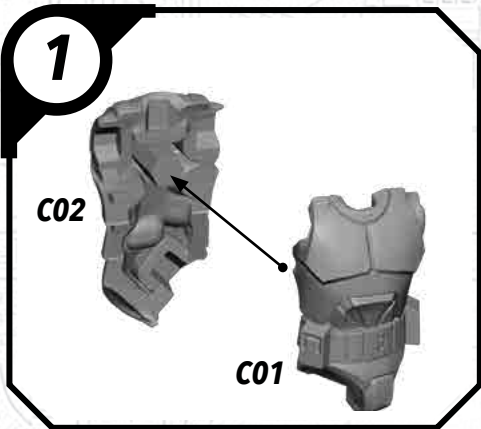

ALL PARTS SHOULD BE ASSEMBLED USING PLASTIC GLUE. PERMISSION GRANTED TO PRINT OR PHOTOCOPY FOR PERSONAL USE.

# SWP06 (D)-CLONE TROOPER POSE A

1

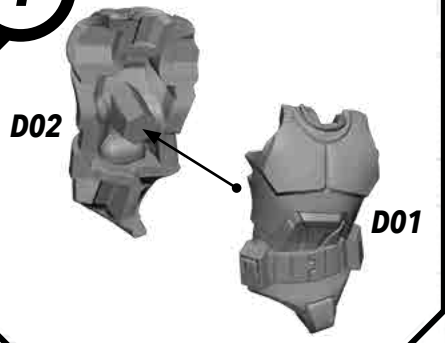

2

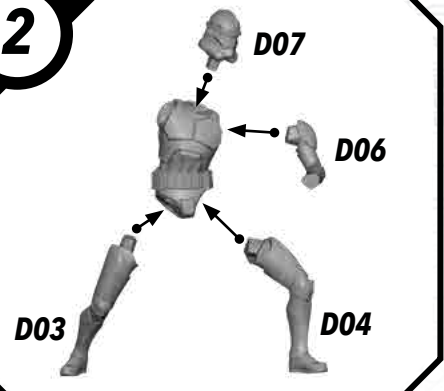

3

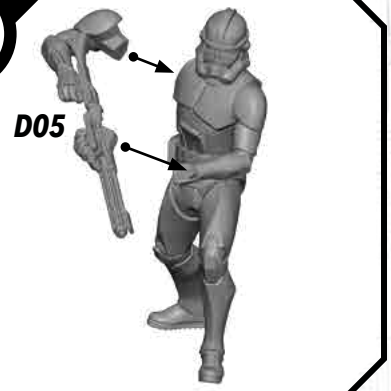

4



FINAL



ALL PARTS SHOULD BE ASSEMBLED USING PLASTIC GLUE. PERMISSION GRANTED TO PRINT OR PHOTOCOPY FOR PERSONAL USE.