

STAR WARS™

LEGION™

READ THIS FIRST

Be sure to use a pair of sharp hobby clippers to remove the miniature components from the sprue. Carefully clean the excess material and mold lines with a sharp hobby knife. Check the fit of each part before gluing. Use a small amount of hobby plastic glue to assemble the components. Use caution with all products and follow all manufacturer instructions. Adult supervision is recommended for children under the age of 16. Have fun!

JOIN THE COMMUNITY

Use #MyStarWarsLegion to share your miniature photos and be a part of the *Star Wars: Legion* community!



AtomicMassGames



AtomicMassGames



Atomic_Mass_Transmissions

GENERAL GRIEVOUS

ASSEMBLY

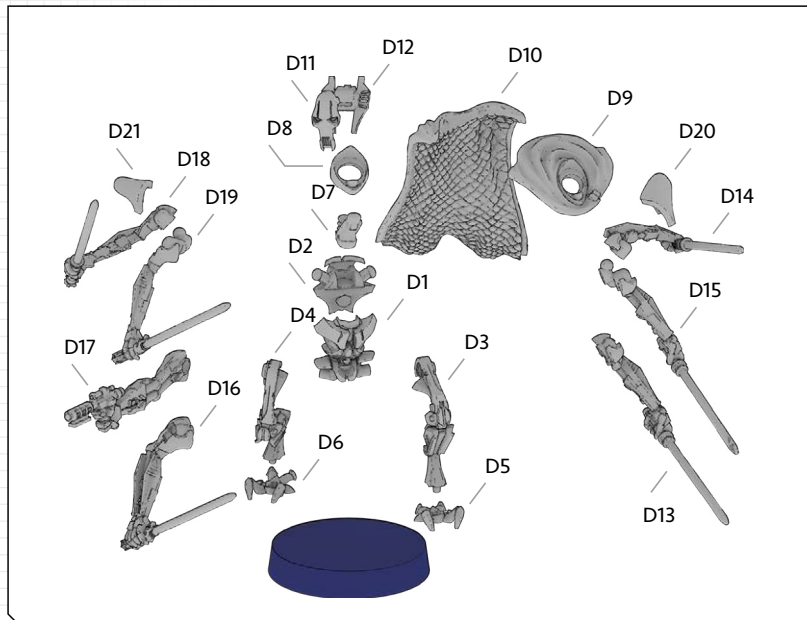

ASSEMBLY OPTIONS

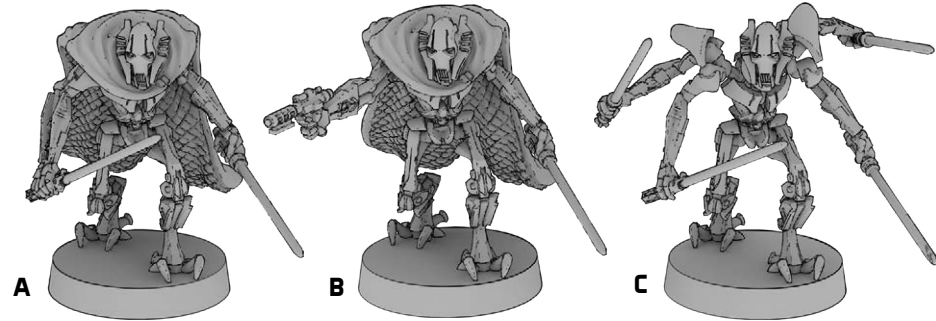

B1 BATTLE DROIDS

ASSEMBLY

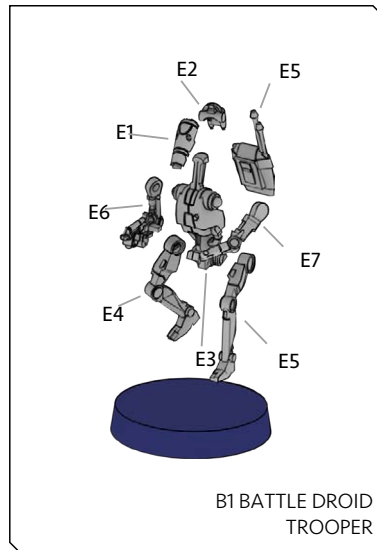
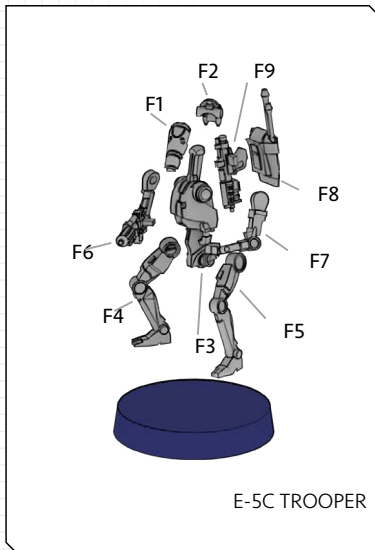
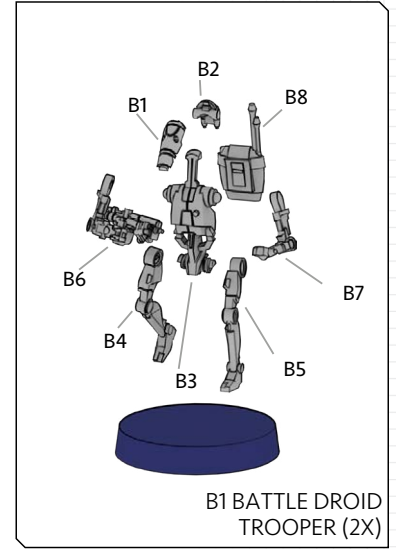
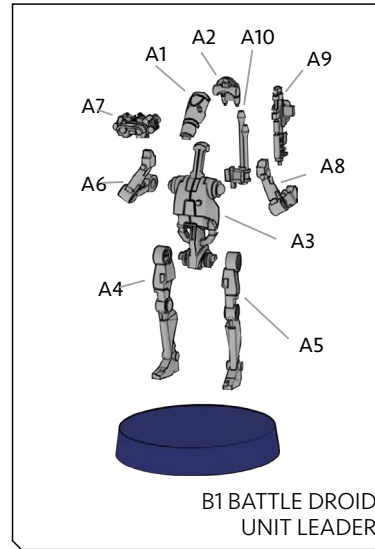
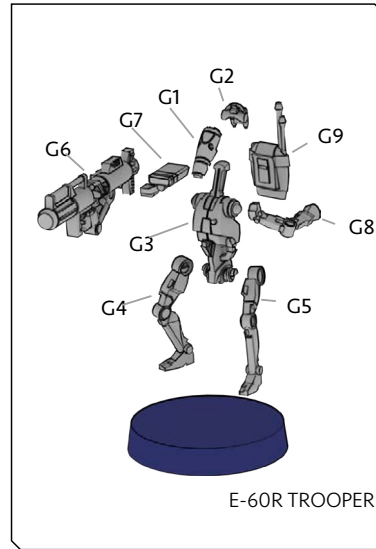
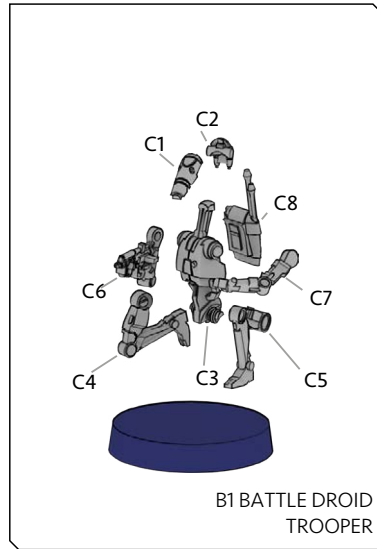
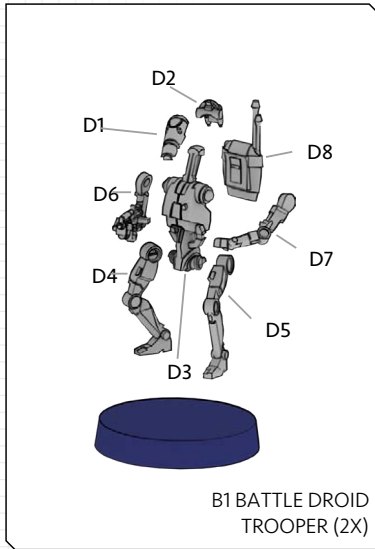

DROIDEKA

ASSEMBLY

STEP 1

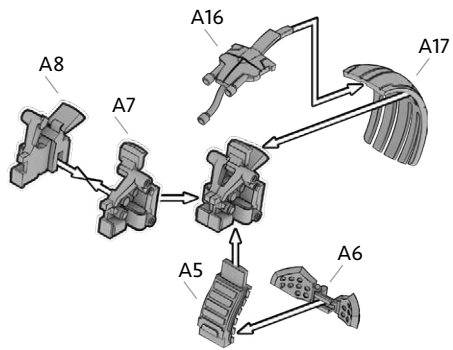

STEP 2

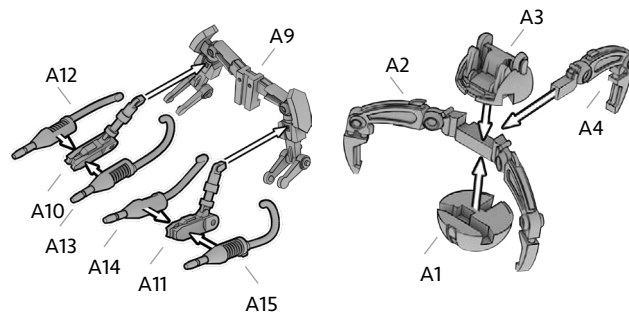

STEP 3

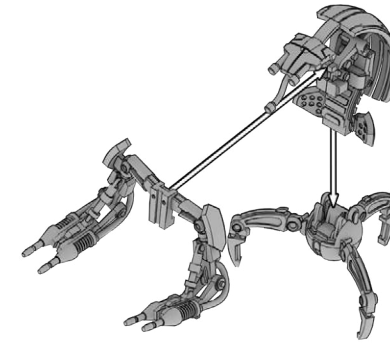

STEP 4

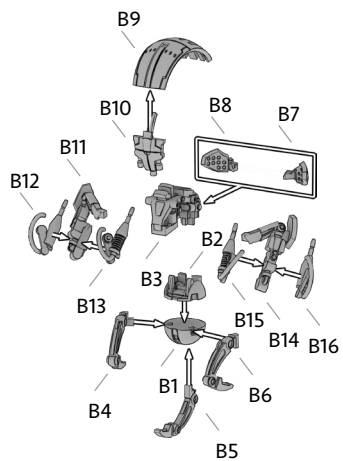

STEP 5

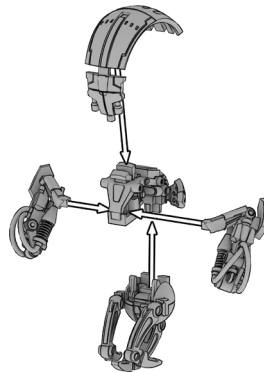

ASSEMBLY OPTIONS

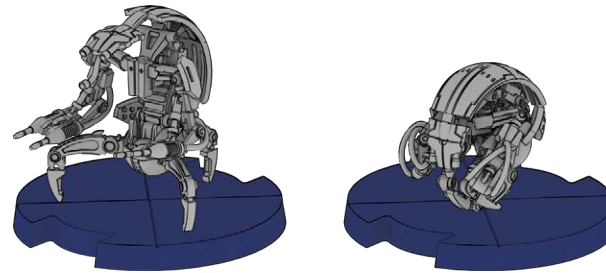

AAT TRADE FEDERATION BATTLE TANK

ASSEMBLY

STEP 1

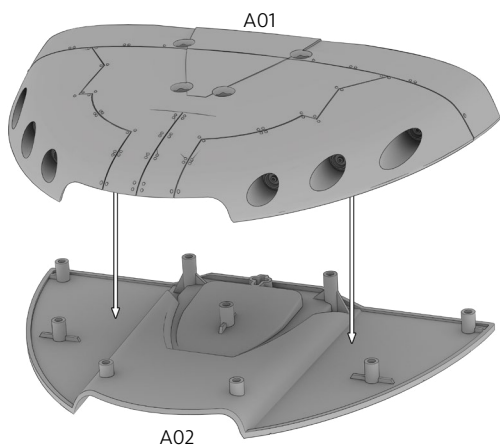

STEP 2

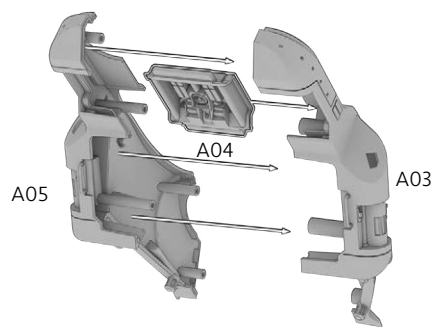

STEP 3

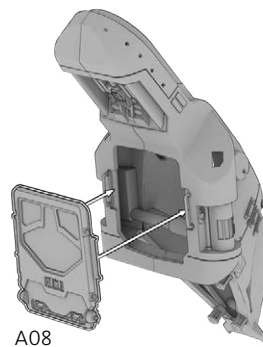

STEP 4

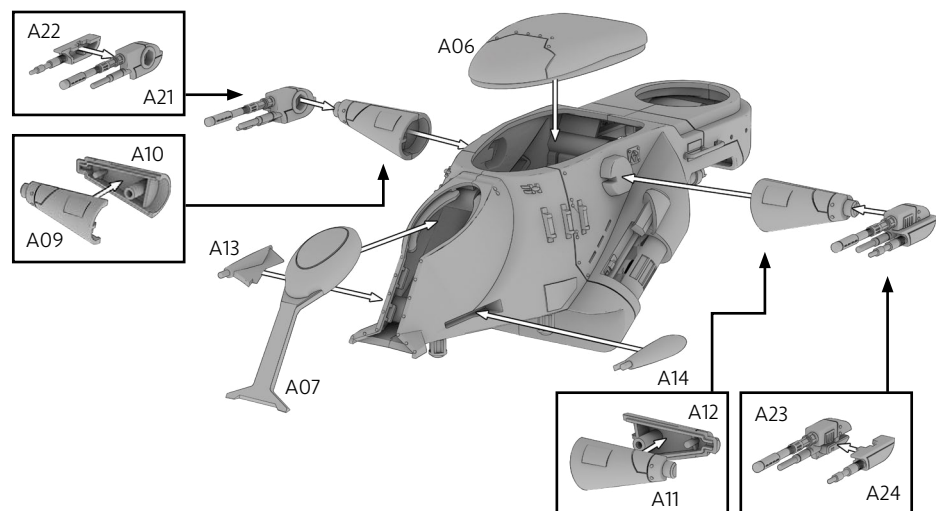

STEP 5

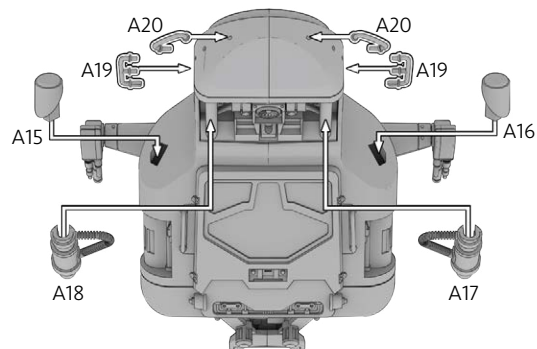

AAT TRADE FEDERATION BATTLE TANK

ASSEMBLY - CONTINUED

STEP 6

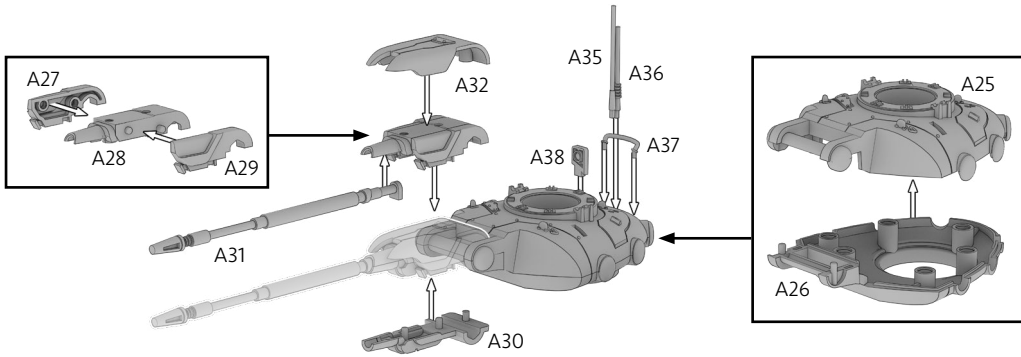

STEP 7

HATCH OPTIONS

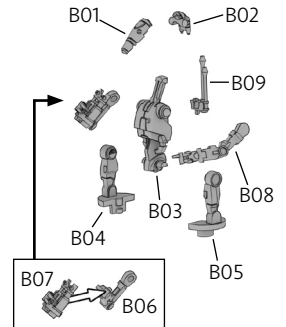
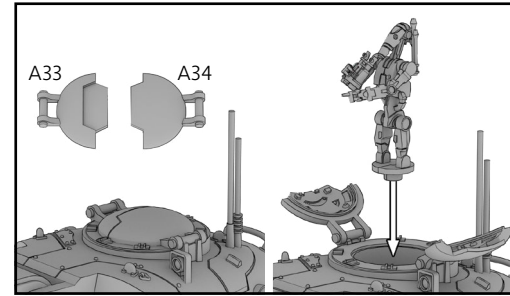

STEP 8

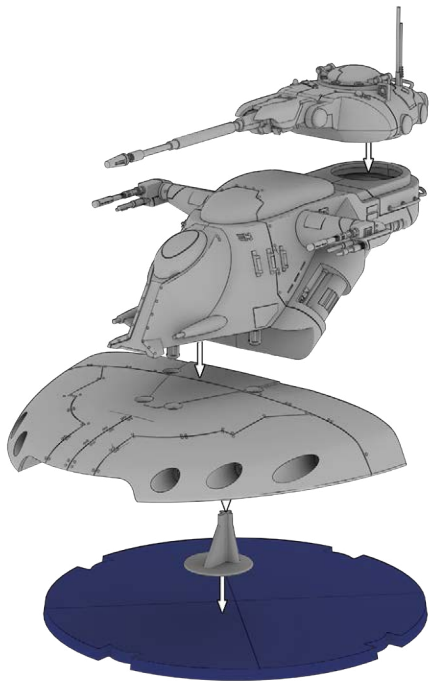

IG-100 MAGNAGUARDS

ASSEMBLY

V2

ASSEMBLY VARIANT 2

V1

ASSEMBLY VARIANT 1

V1

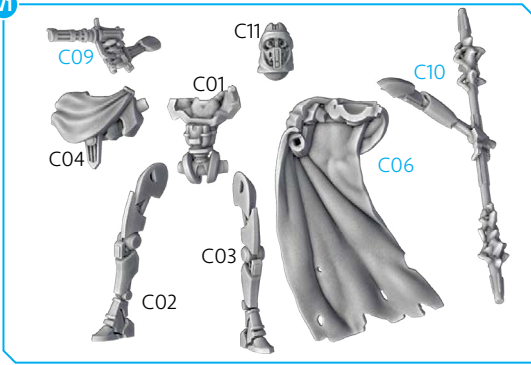

V2

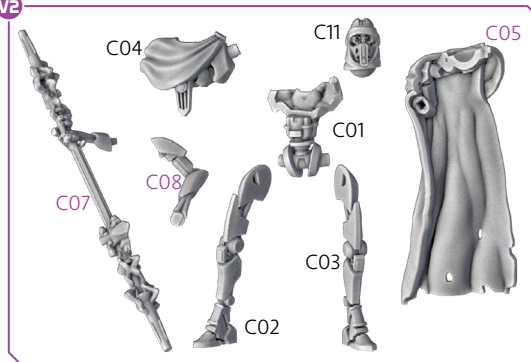

V1

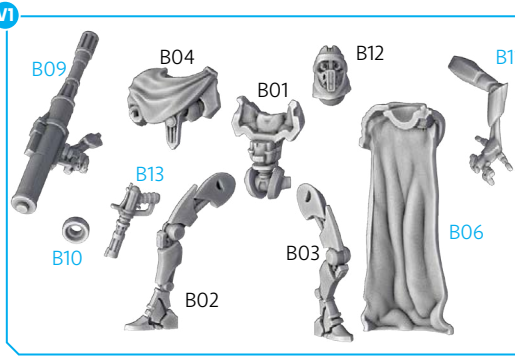

V2

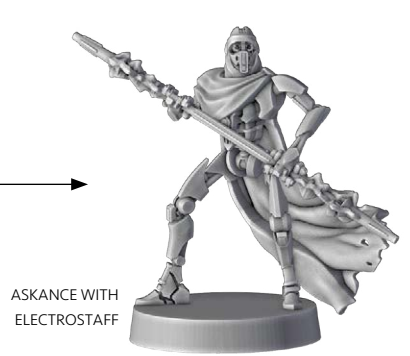
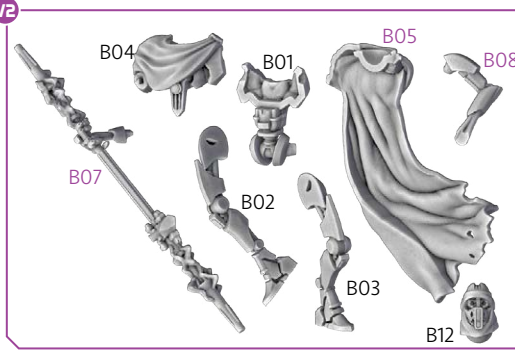

V1

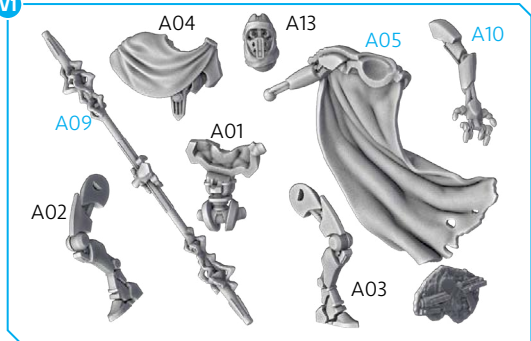

V2

