

# STAR WARS™ LEGION™

HONDO OHNAKA &  
WEEQUAY PIRATES  
(SWQ 45)

## READ THIS FIRST

STOP! Before assembling, please visit [atomicmassgames.com/SWLegion](http://atomicmassgames.com/SWLegion) and download the assembly instructions. Be sure to use a pair of sharp hobby clippers to remove the miniature components from the frame. Carefully clean the excess material and mold lines with a sharp hobby knife. Check the fit of each part before gluing. Use a small amount of hobby plastic glue to assemble the components.

Use caution with all products and follow all manufacturer instructions. Adult supervision is recommended for children under the age of 16. Have fun!

## JOIN THE COMMUNITY

Use #MyStarWarsLegion to share your miniature photos and be a part of the Star Wars™: Legion community!



AtomicMassGames



AtomicMassGames



Atomic\_Mass\_Transmissions

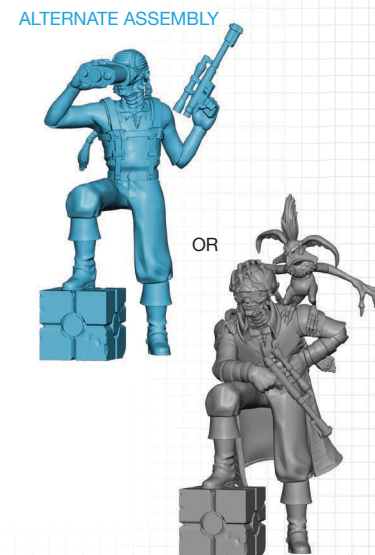
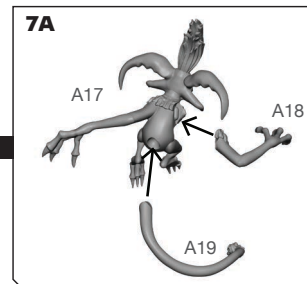
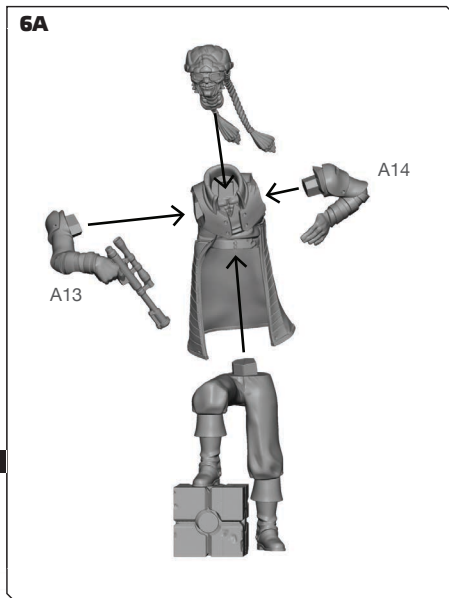
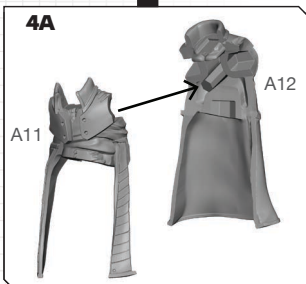
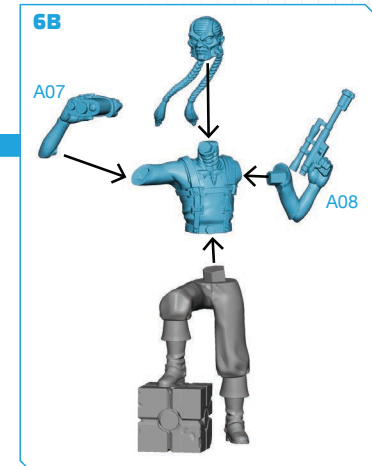
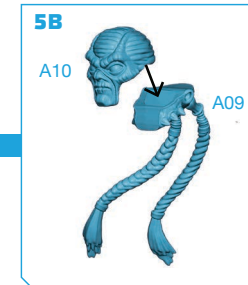
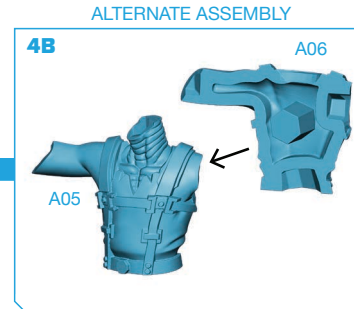
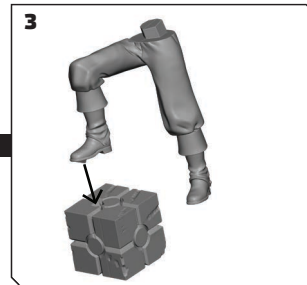
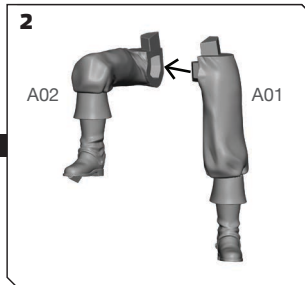
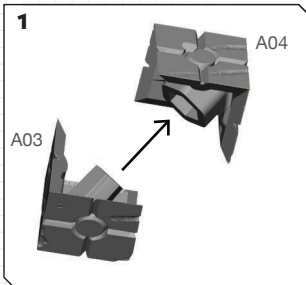

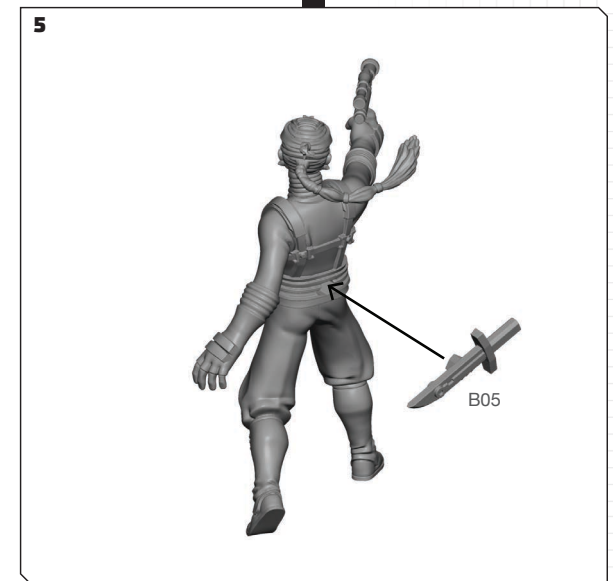
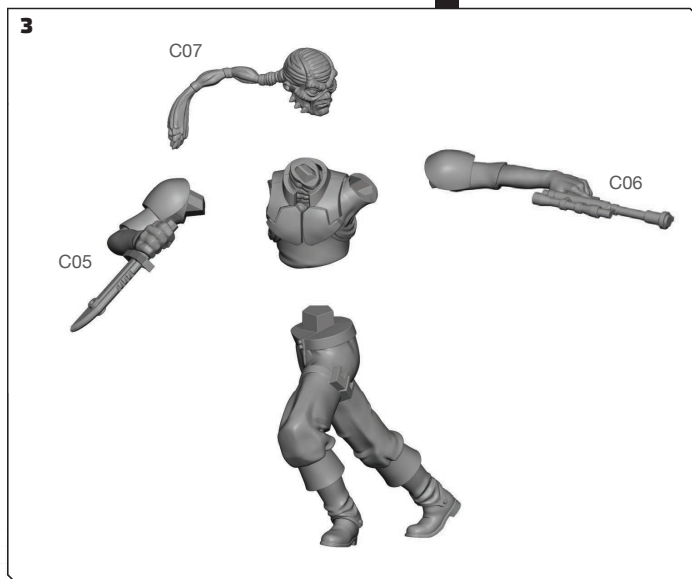
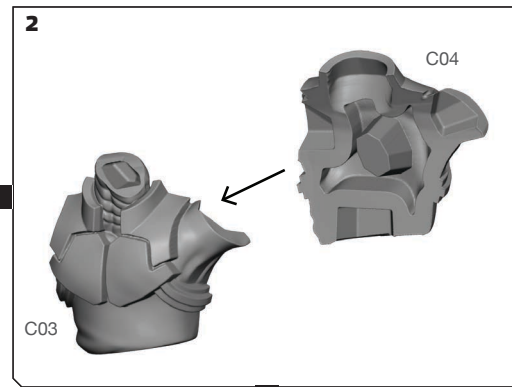
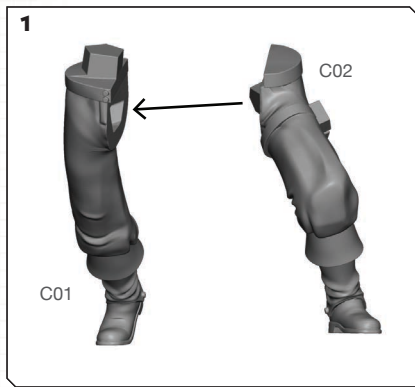
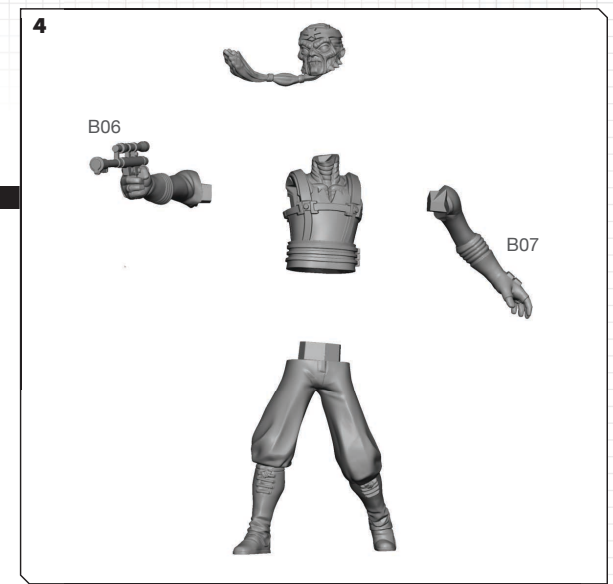
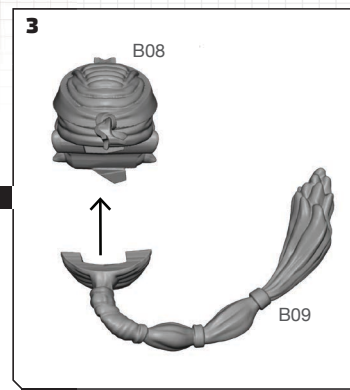
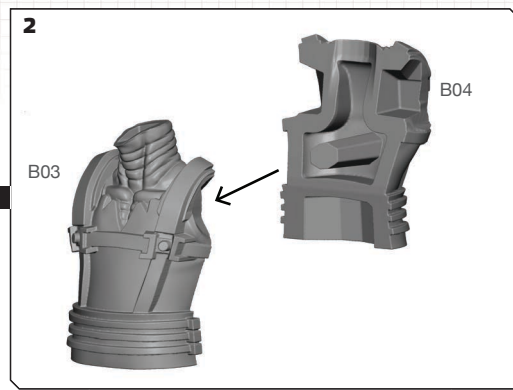
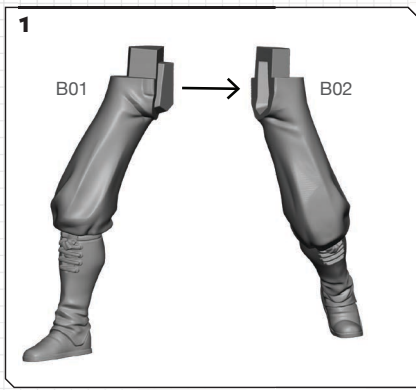

Enough parts to assemble D (x2) **or** D (x1) and F (x1):



D



F

Enough parts to assemble E (x2) **or** E (x1) and G (x1):



E



G

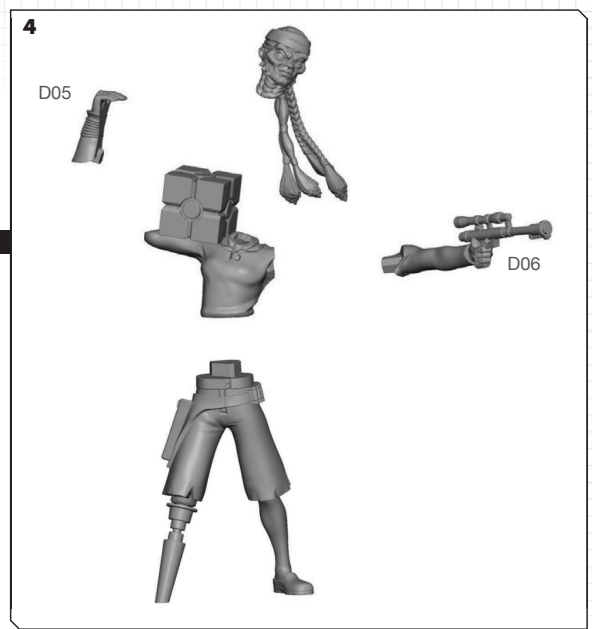
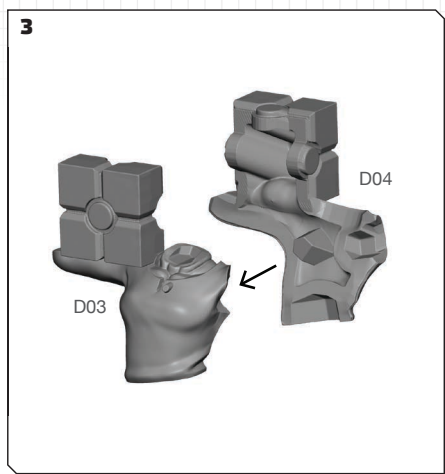
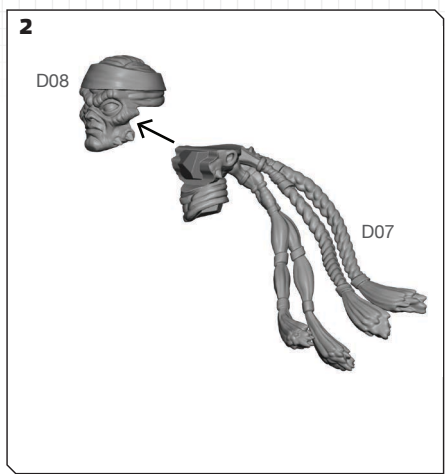
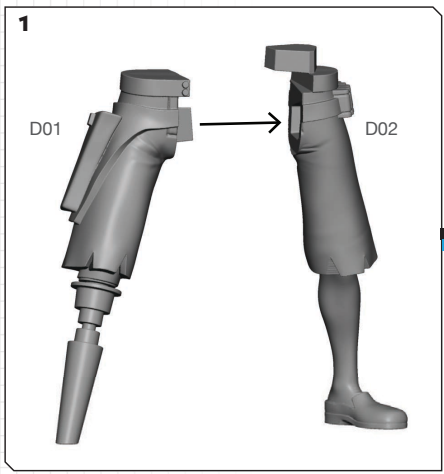

ALTERNATE ASSEMBLY

