

MARVEL CRISIS PROTOCOL

MINIATURES GAME

CP 100

READ THIS FIRST

Be sure to use a pair of sharp hobby clippers to remove the miniature components from the sprue. Carefully clean the excess material and mold lines with a sharp hobby knife. Check the fit of each part before gluing. Use a small amount of hobby plastic glue to assemble the components. Use caution with all products and follow all manufacturer instructions. Adult supervision is recommended for children under the age of 16. Have fun!

JOIN THE COMMUNITY

Use #PaintingProtocol to share your miniature photos and be a part of the Marvel: Crisis Protocol community!



AtomicMassGames



AtomicMassGames



Atomic_Mass_Transmissions

AGENT VENOM ASSEMBLY GUIDE

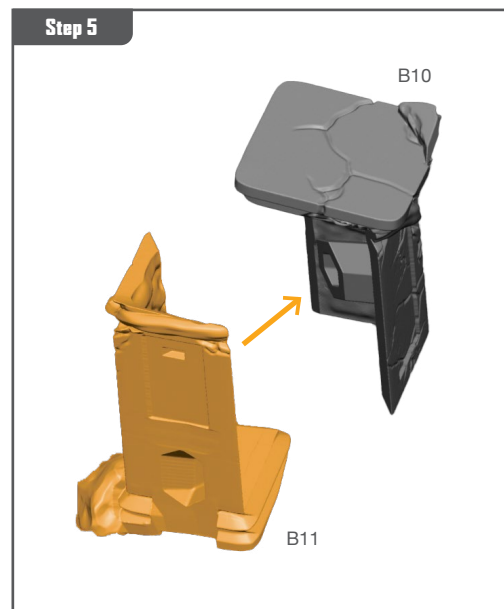
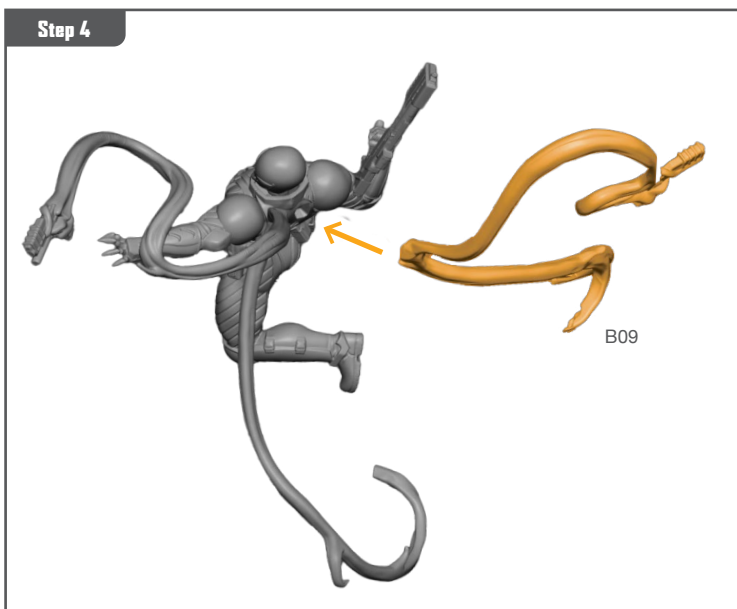
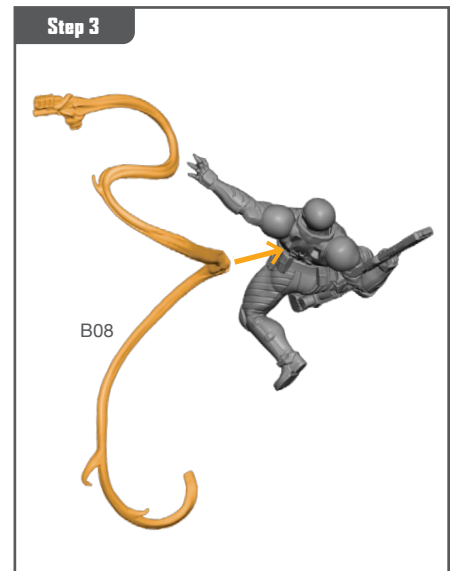
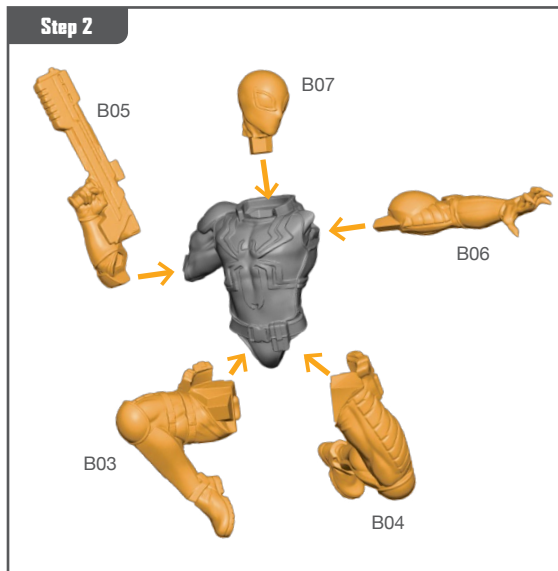
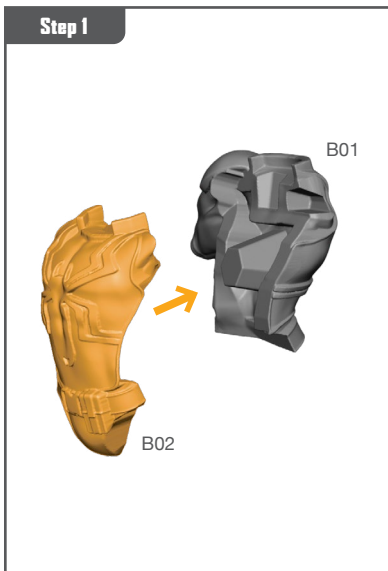

Permission granted to print or photocopy for personal use.



Atomic Mass Games and logo are TM of Atomic Mass Games.
Atomic Mass Games, 1995 County Road B2 W, Roseville, MN, 55113, USA, 1-651-639-1905.
Actual components may vary from those shown.

AGENT VENOM ASSEMBLY GUIDE (CONTINUED)

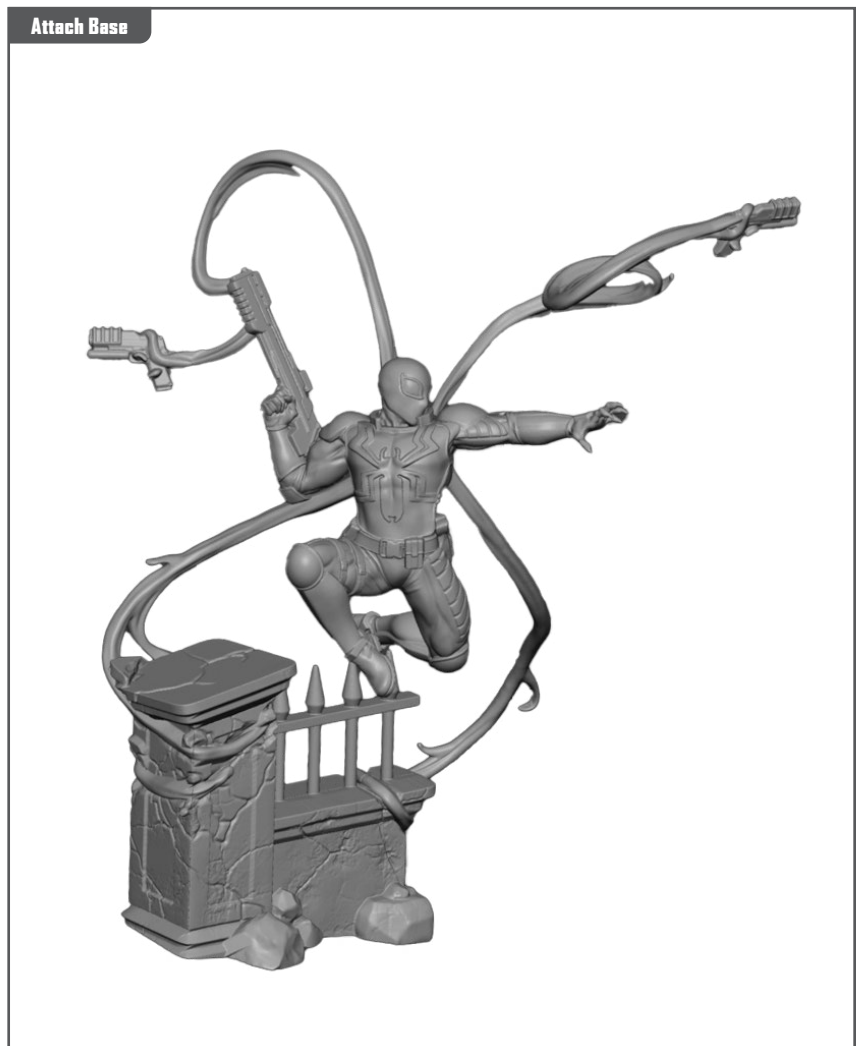
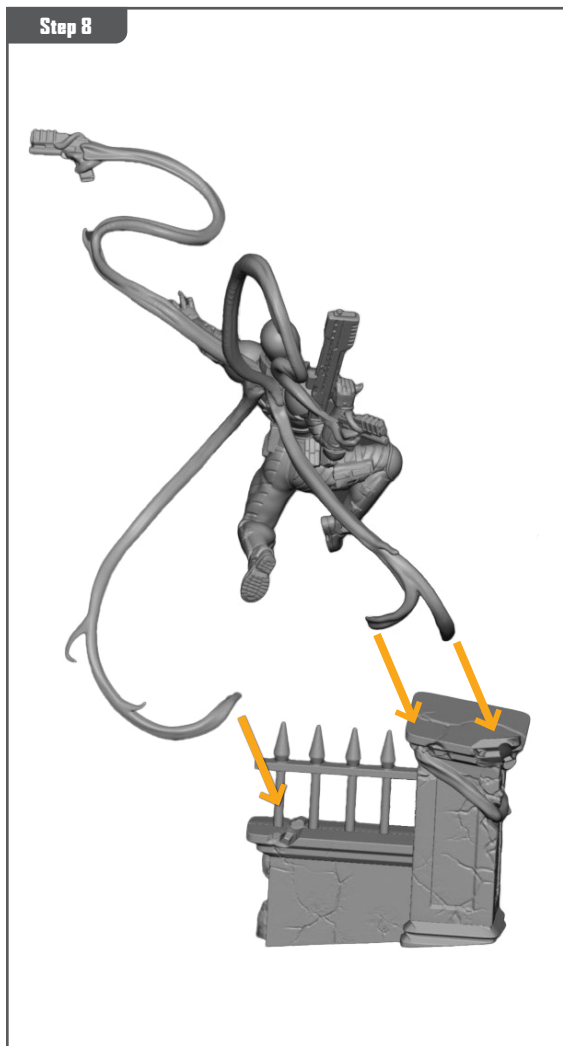
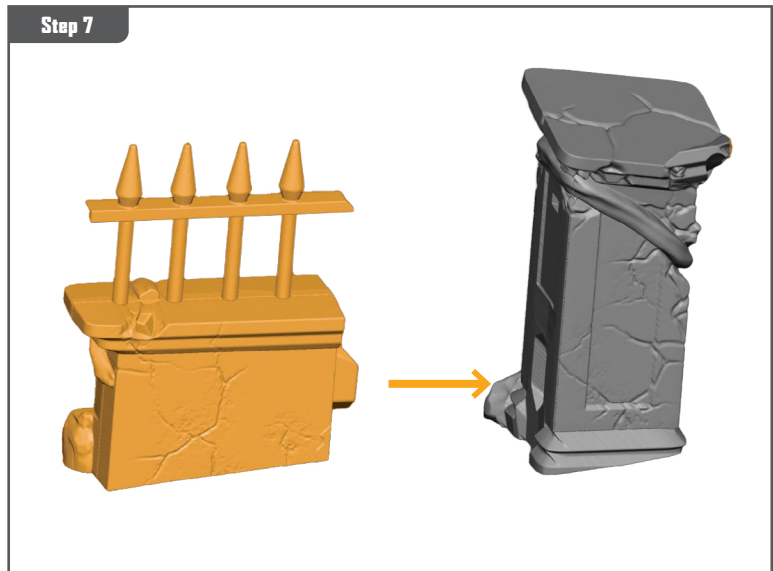
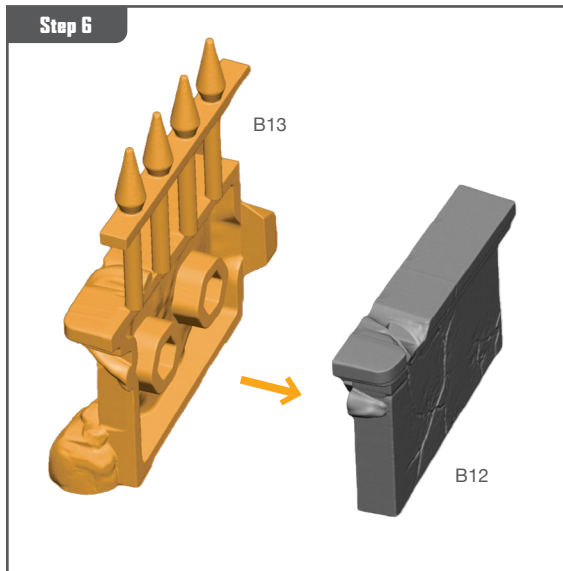

Permission granted to print or photocopy for personal use.



Atomic Mass Games and logo are TM of Atomic Mass Games.
Atomic Mass Games, 1995 County Road B2 W, Roseville, MN, 55113, USA, 1-651-639-1905.
Actual components may vary from those shown.

SPIDER-WOMAN ASSEMBLY GUIDE

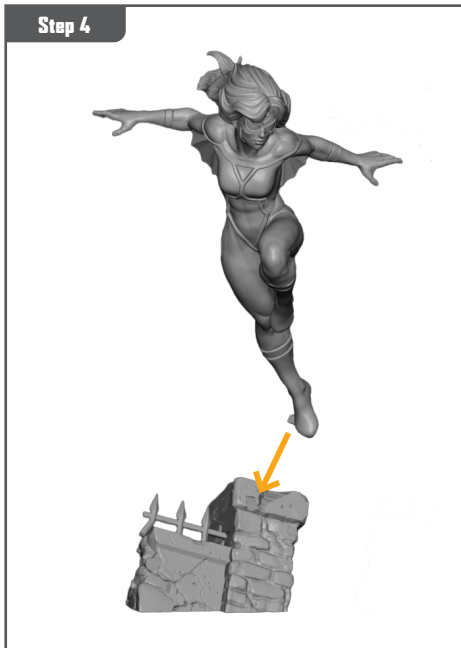
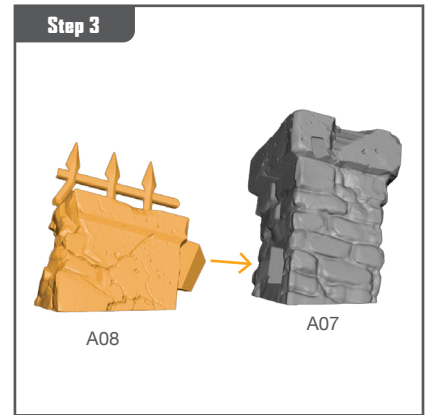
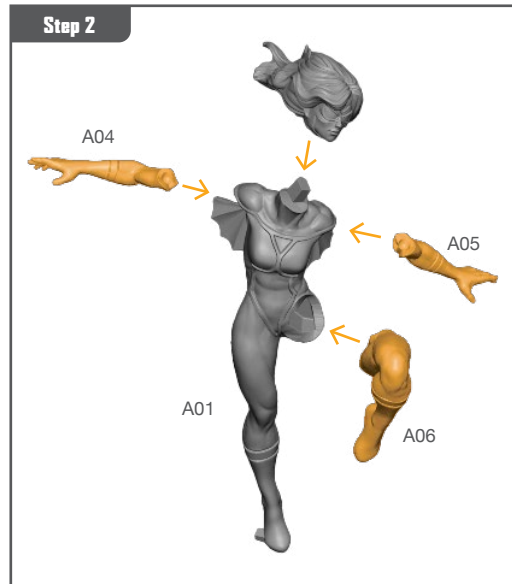
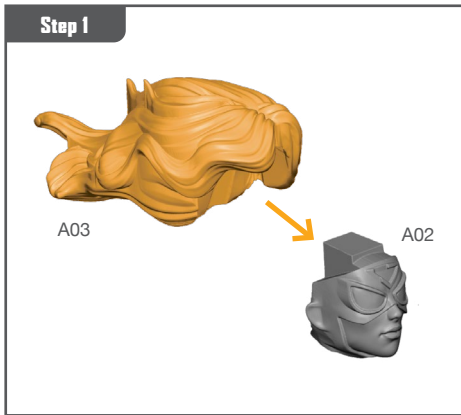

Permission granted to print or photocopy for personal use.



Atomic Mass Games and logo are TM of Atomic Mass Games.
Atomic Mass Games, 1995 County Road B2 W, Roseville, MN, 55113, USA, 1-651-639-1905.
Actual components may vary from those shown.