

# MARVEL CRISIS PROTOCOL MINIATURES GAME

CP 16

## READ THIS FIRST

Read through the instruction booklet before assembling your miniatures. Be sure to use a pair of sharp hobby clippers to remove the miniature components from the sprue. Carefully clean the excess material and mold lines with a sharp hobby knife. Check the fit of each part before gluing. Use a small amount of hobby plastic glue to assemble the components. Use caution with all products and follow all manufacturer instructions. Adult supervision is recommended for children under the age of 16. Have fun!

## CREDITS

### Marvel Crisis Protocol

#### Game and Character Design

William Shick

#### Lead Developer

Will Pagani

#### Sculpting Director

Dallas Kemp

#### Digital Engineering

Marco Segovia, Michael Jenkins

#### Sculptor

Gael Goumon

#### Miniature Painting

Brendan Roy

### Marketing

Josh Colón

### Graphic Design & Photography

Jessy Stetson

### Editing

Dan Henderson

### Art Director

Zoë Robinson

### Plastics Production Management

Justin Anger, Michael Blomberg

### Print Production Management

Liza Lundgren, John Hannasch, Anne Kinner

### Publisher

Steve Horvath

### Marvel

### Licensing Approvals

Brian Ng

### Asmodee North America

#### Licensing Coordinator

Sherry Anisi

#### Director of Licensing

Simone Elliott

## GAMORA ASSEMBLY GUIDE

### Step 1

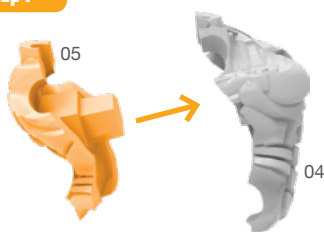

### Step 2

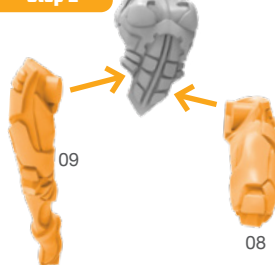

### Step 3



### Step 4



### Step 5

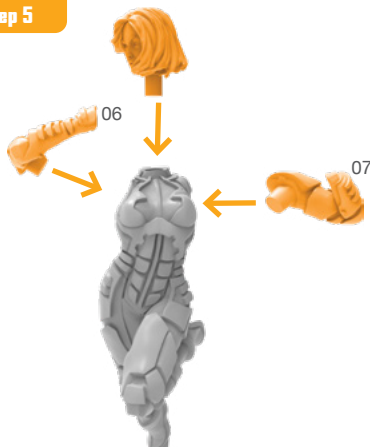

### Step 6

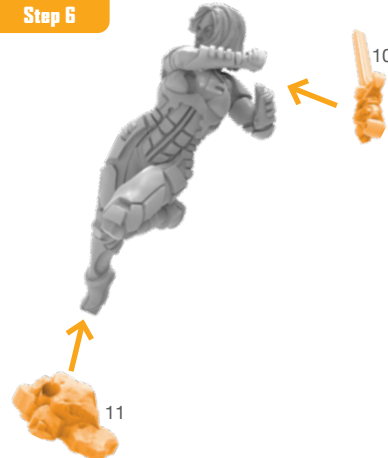

### Attach Base



# NEBULA ASSEMBLY GUIDE

Step 1

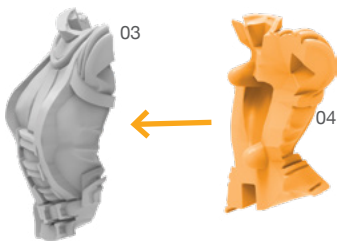

Step 2

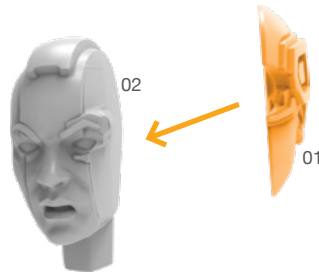

Step 3

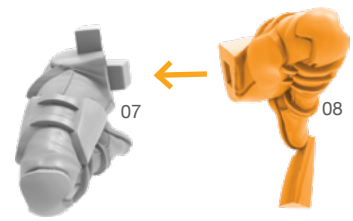

Step 4



Step 5

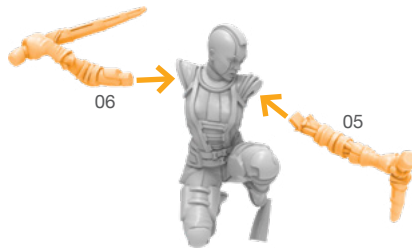

Step 6

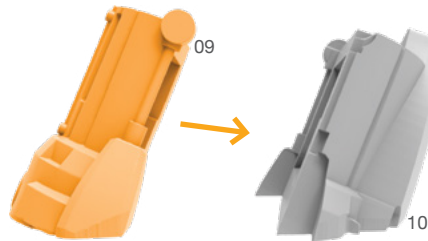

Step 7

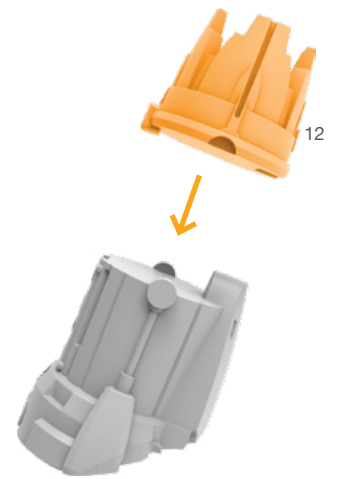

Step 8

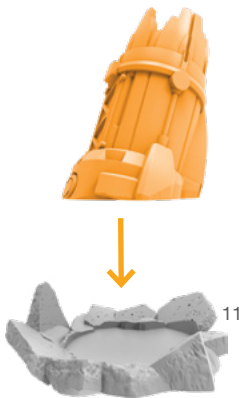

Step 9



Attach Base

